



Kea Keuringen en Energie Advies vzw

erkend keuringsorganisme MB 5 nov. 2010

Renaat de Rudderstraat 48a
9850 Landegem
BTW BE0821 773 706

TEL/FAX: 09 282 58 88
info@keakeuringen.be
www.keakeuringen.be



PROCES-VERBAAL VAN GELIJKVORMIGHEIDSONDERZOEK EN/OF CONTROLEBEZOEK VAN EEN ELEKTRISCHE LAAGSPANNINGSINSTALLATIE

Ref: **Dossiernr:** 18-0692 **Aanvrager:** Engel & Völkers Latem bvba
Datum: 27/02/2019 **Verslagnr:** KV8176-MCH **Inspecteur:** Mounier Chebil
Installatie **Verantwoordelijke werken**
Woonenheid Bonte Danny
Karperstraat 25 BTW: BE 0782.070.220
9800 Astene

Onderzoek: AREI Art 271 (Art 86, Art 278)

Algemene gegevens elektrische installatie

Gegevens verdeler

EAN: niet meegedeeld
kWh meter nr.: 4150301

Bescherming aansluiting: 40 A
Meterstand dag: 146057 kWh

Budgetmeter
Meterstand nacht: 110938 kWh

Gegevens installatie

Ontworpen voor: 3N400V
Max nominale stroom: 40 A

Voedingsleiding hoofdbord: 4 x 10 mm²
Type voedingsleiding: VOB

Type aardelektrode: pen/baar

Beschrijving installatie

Algemene differentieelstroomrichting: 40 A / 300 mA

Aantal schakelborden: 3

Aantal eindstroombanen: 20

| Schakelbord 1 | Schakelbord 2 | Schakelbord 3 |
|--|---|---|
| 1 x 20A - 2P | 4 x 16A - 2P 4 x 20A - 2P | 3 x 16A - 2P 7 x 20A - 2P 1 x 20A - 3P |
| Differentiaalschakelaar 100mA - 40 - 4P Type: A | Differentiaalschakelaar 30mA - 40 - 4P Type: A | Differentiaalschakelaar 30mA - 40 - 4P Type: A |

Controles

- | | | | |
|---|---|--|--|
| <input checked="" type="checkbox"/> Rechtstreekse aanraking | <input checked="" type="checkbox"/> Onrechtstreekse aanraking | <input checked="" type="checkbox"/> Montage | <input checked="" type="checkbox"/> Toestellen |
| <input checked="" type="checkbox"/> Materieel | <input checked="" type="checkbox"/> I>/doorsnede | <input checked="" type="checkbox"/> Schemas | <input checked="" type="checkbox"/> Controle foutlus |
| <input checked="" type="checkbox"/> Aardingscontinuïteit | <input checked="" type="checkbox"/> Test DSI | <input checked="" type="checkbox"/> Differentieelstroomrichting: was verzegeld | |

Metingen

- Aardingsweerstand: 19.2 Ohm Algemeen isolatieniveau: 4.78 MOhm bij 500 V



Kea Keuringen en Energie Advies vzw

erkend keuringsorganisme MB 5 nov. 2010

Renaat de Rudderstraat 48a
9850 Landegem
BTW BE0821 773 706

TEL/FAX: 09 282 58 88
info@keakeuringen.be
www.keakeuringen.be



Inbreuken

Inbreuken bestaande installatie

Geen geconstateerd

Opmerkingen

W009 - Dit verslag dient toegevoegd te worden aan het elektrisch dossier van de bestaande installatie!

Controle enkel uitgevoerd op de zichtbaar en bereikbare delen.

De klant/vertegenwoordiger verklaart dat de installatie na keuring opnieuw functioneel is.

Besluiten

De bestaande installatie voldoet aan het AREI

De installatie voldoet.
Dit keuringsattest is geldig tot 27/02/2044

Bijlagen

1. Eéndraads- en installatieschema (16 pagina's)

Digitaal ondertekend
06/03/2019
Mounier Chebil

Visa

Kea Keuringen en Energie Advies vzw
Renaat de Rudderstraat 48a - 9850 Landegem
tel/fax 09 282 58 88 - gsm 0474/72 43 51
www.keakeuringen.be - info@keakeuringen.be
BTW BE0821 773 706

Eddy Ryckaert
KEA

BORD III

| | | | |
|----------------------|--------|--------|--------|
| diff 300mA 4P/40A | 4P/40A | 4P/32A | 2P/20A |
|----------------------|--------|--------|--------|

A

B

C

27/01/2015



Bontje vanuy



van Rijkswijk



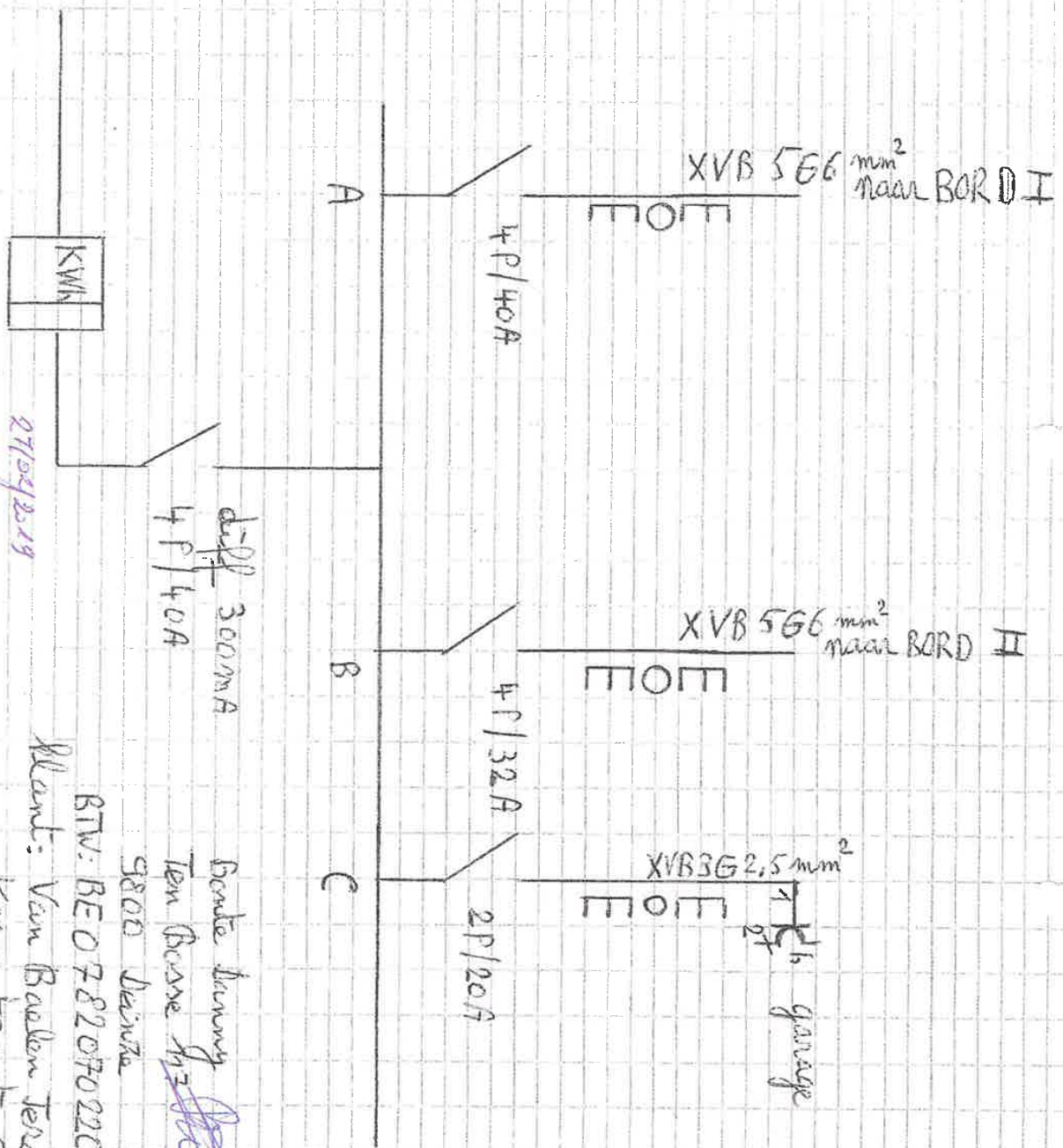

BORD III

Boote leuning
Ten Borse ~~1/3~~
9800 Deurne

RTW: BE 0782070220

Klant: Van Baalen Jensen
Kampstraat 25
9800 Deurne

BORD 1

| | | | | |
|--------|-----|-----|-----|-----|
| 4P/40A | 2P | 2P | 2P | 2P |
| 30mA | 16A | 16A | 20A | 20A |
| | E | F | G | H |

| | | | | |
|--------|-----|-----|-----|-----|
| 4P/40A | 2P | 2P | 2P | 2P |
| | 16A | 16A | 20A | 20A |
| | A | B | C | D |

28/10/2019

Bonnie Jansing

van Galen

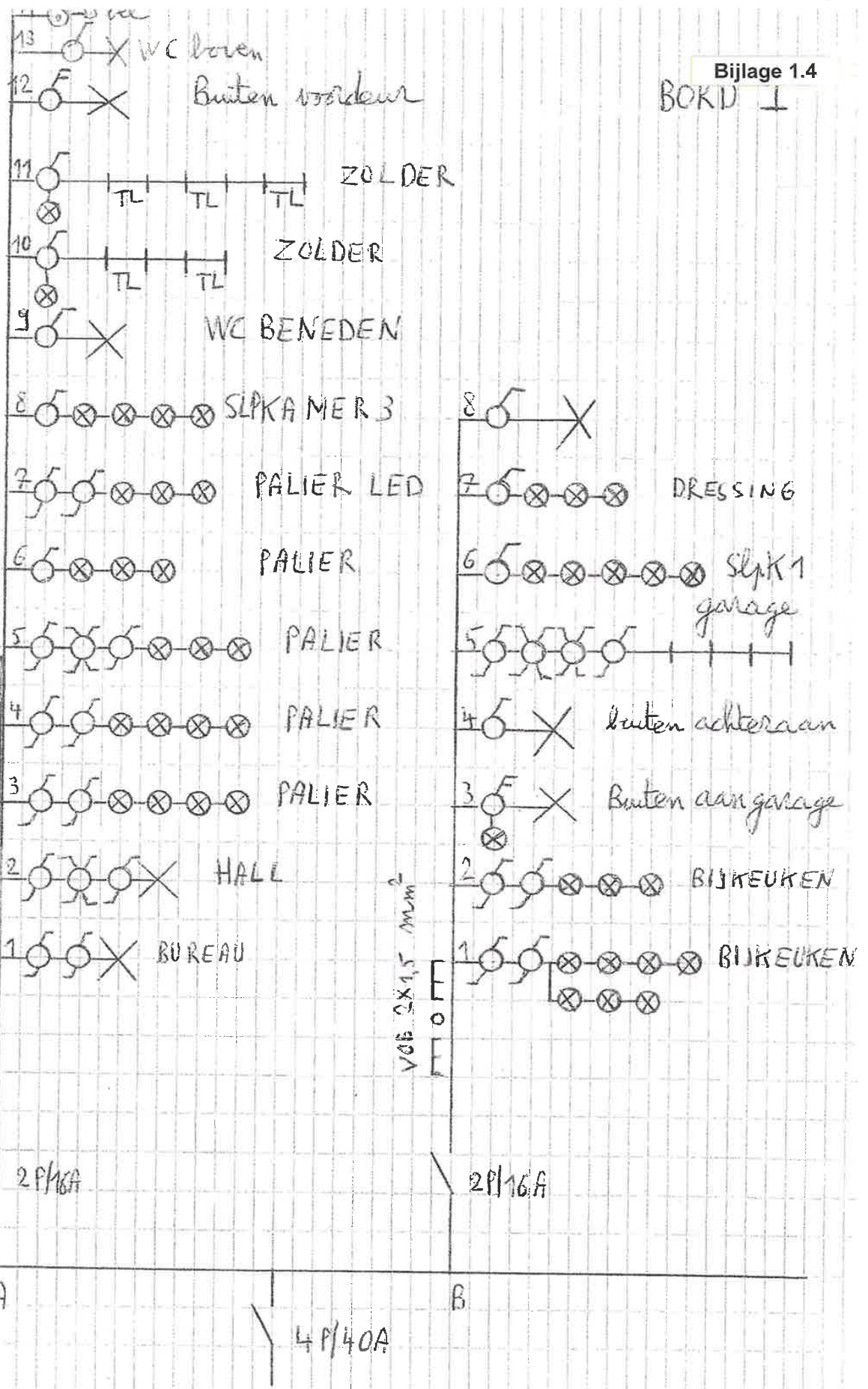



27/02/2019
Ronde vanavond
verloft van
Jules

BORD I

garage

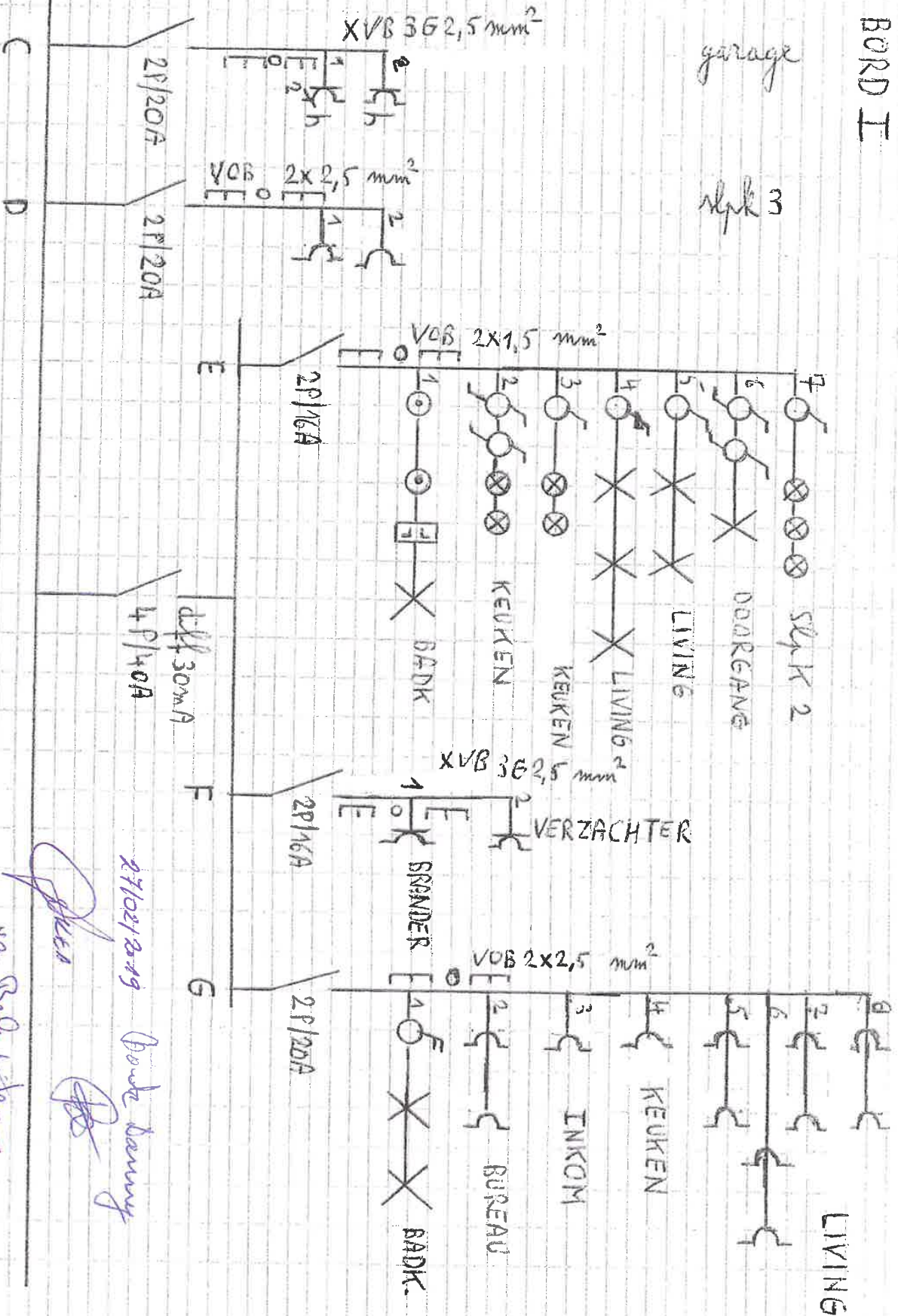
slk 3



27/02/2019 Bobt Lemmy

[Signature]

van Beeldt Jansen

[Signature]

BORD I

RESERVE

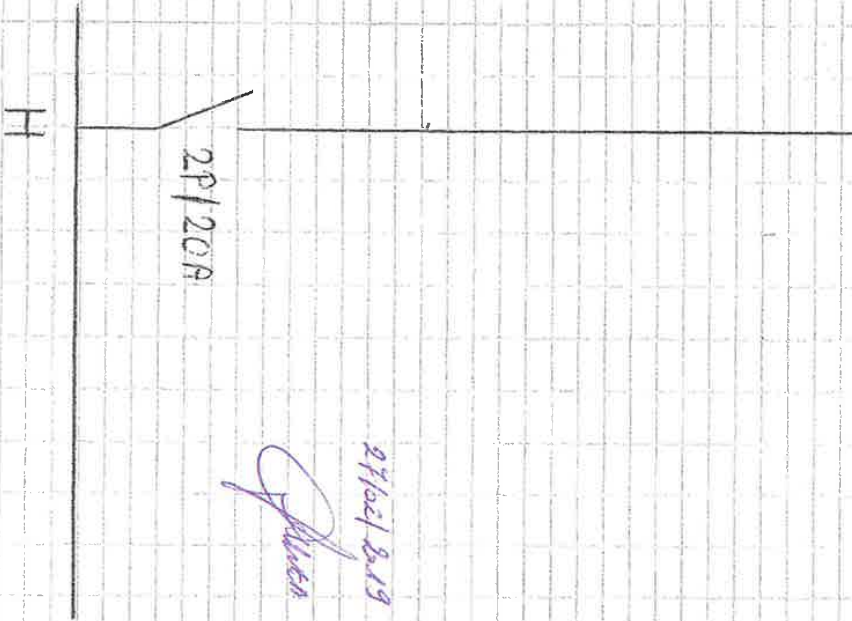

21/02/2013
[Signature]

Bonke Danny
[Signature]

van Rolin Jans
[Signature]

BORD II

| | | | | | |
|-----|-----|-----|-----|-----|-----|
| 2P | 2P | 2P | 2P | 2P | 2P |
| 16A | 16A | 16F | 20A | 20A | 20A |
| A | B | C | D | E | F |

| | | | | | |
|-----|-----|-----|-----|-----|------|
| 2P | 2P | 2P | 2P | 0 | 100% |
| 20A | 20A | 20A | 20A | out | |
| G | H | I | J | 1 | |

| | |
|----------|-----|
| dip 30mA | 3P |
| 4P/40A | 20A |

27/02/2019

[Signature]

[Signature]

Borde kanning

van 30m pas
[Signature]

BORD II

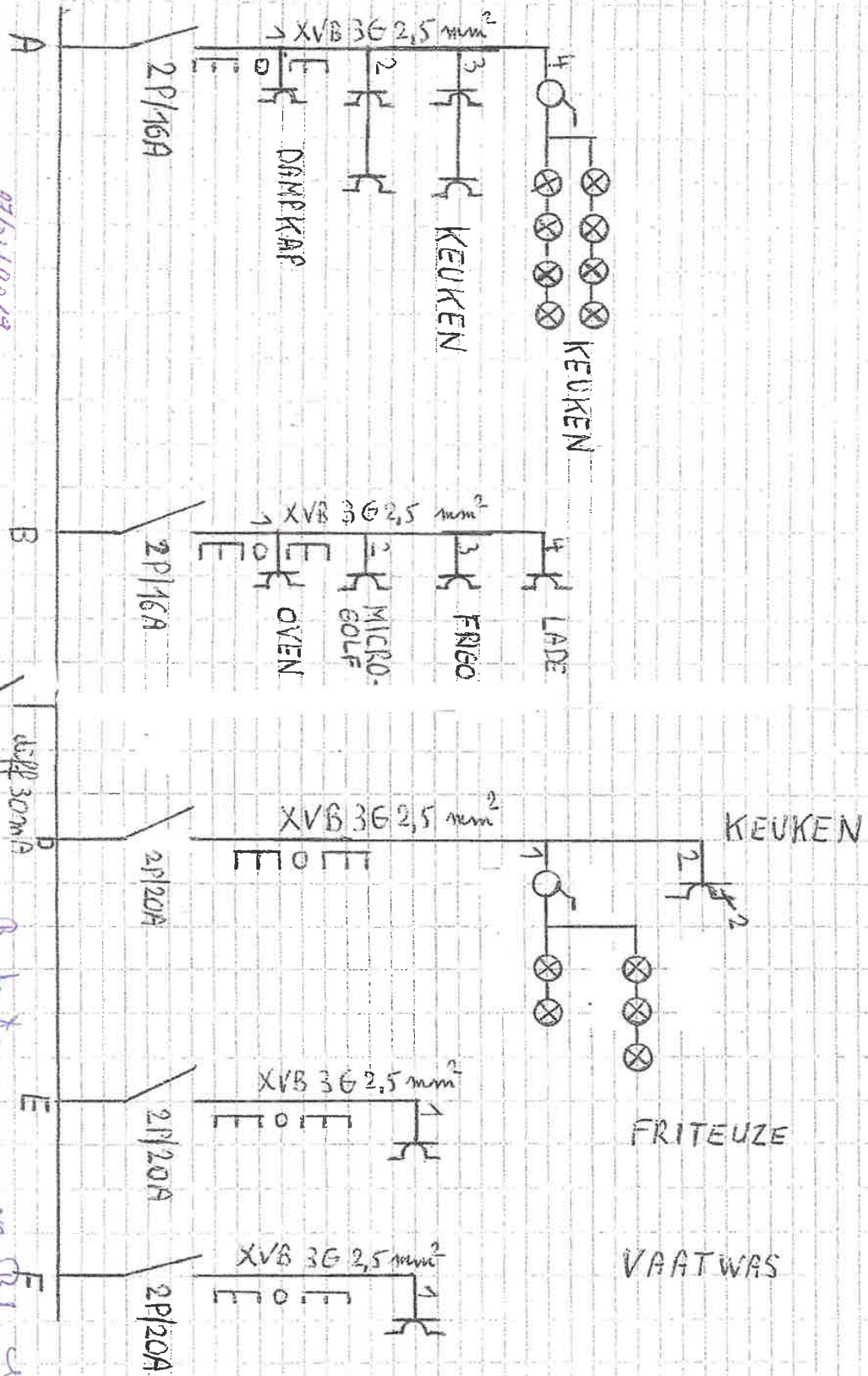

27/04/2013

[Signature]

diff 30mA
4P/40A

[Signature]
Donke Jansing

[Signature]
van Boven J. van

BORD II

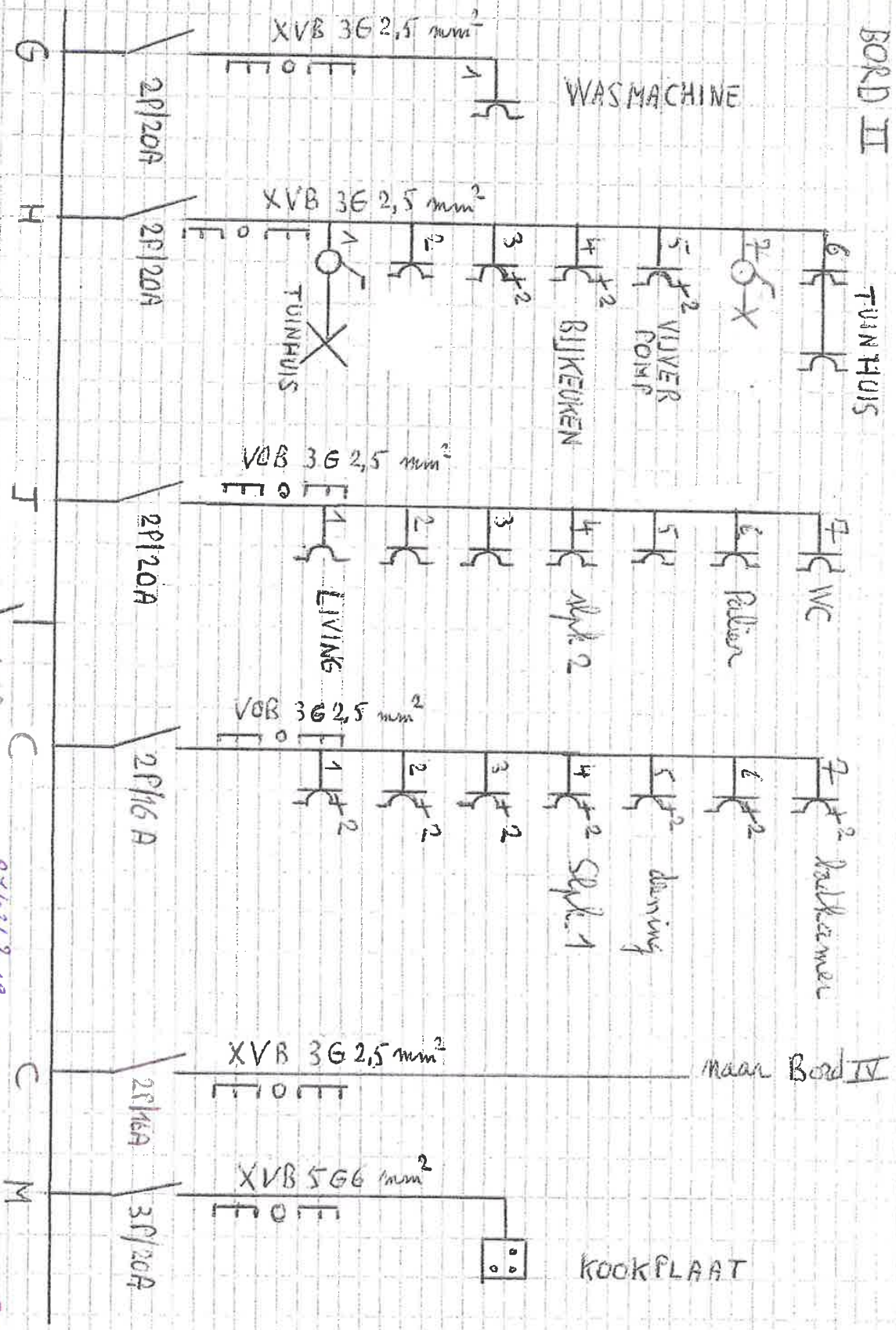

diff 30mA
4P/40A

27.10.2019

[Signature]

Bouke Jansing

[Signature]

BORD IV

| | | | |
|---------------------------|--------------------------|-----------|-----------------------|
| bransfo E212 SC 100 SK | bransfo E212 SC 300SK | | |
| FB 6/1250 | FB 6/1250 | | |
| niko dimmer 05-728 | niko dimmer 05-728 | 2P 16A | teleprinter 2F/16A |

27/02/2019

[Signature]

Brake Danny

[Signature]

van Bal Jean

[Signature]

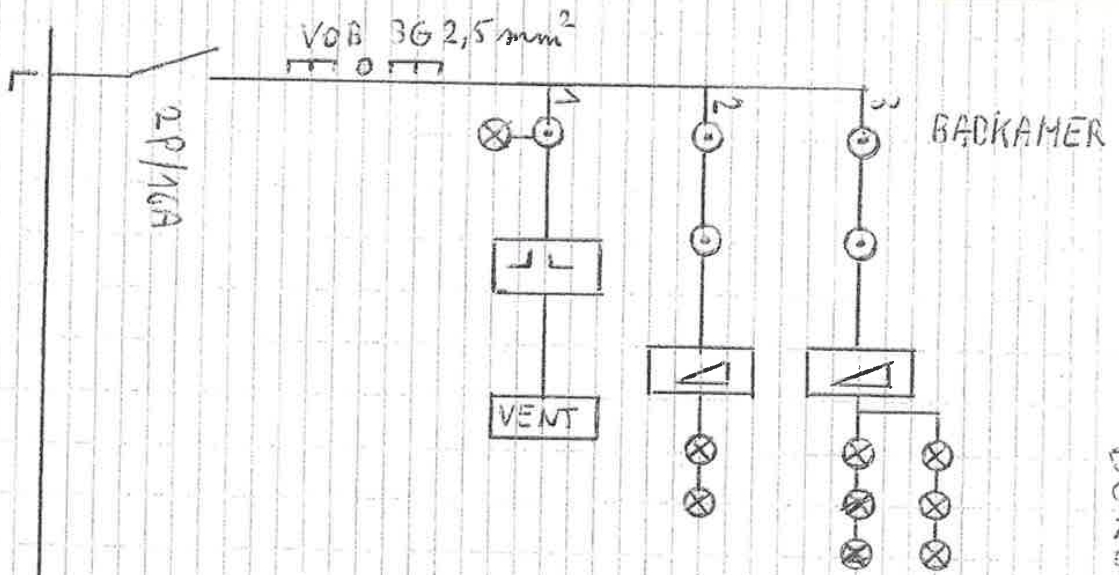

BORD IV

21/04/2013
[Signature]

[Signature]
 Ronde kuny

[Signature]
 van Balem Jan

ZOLDER

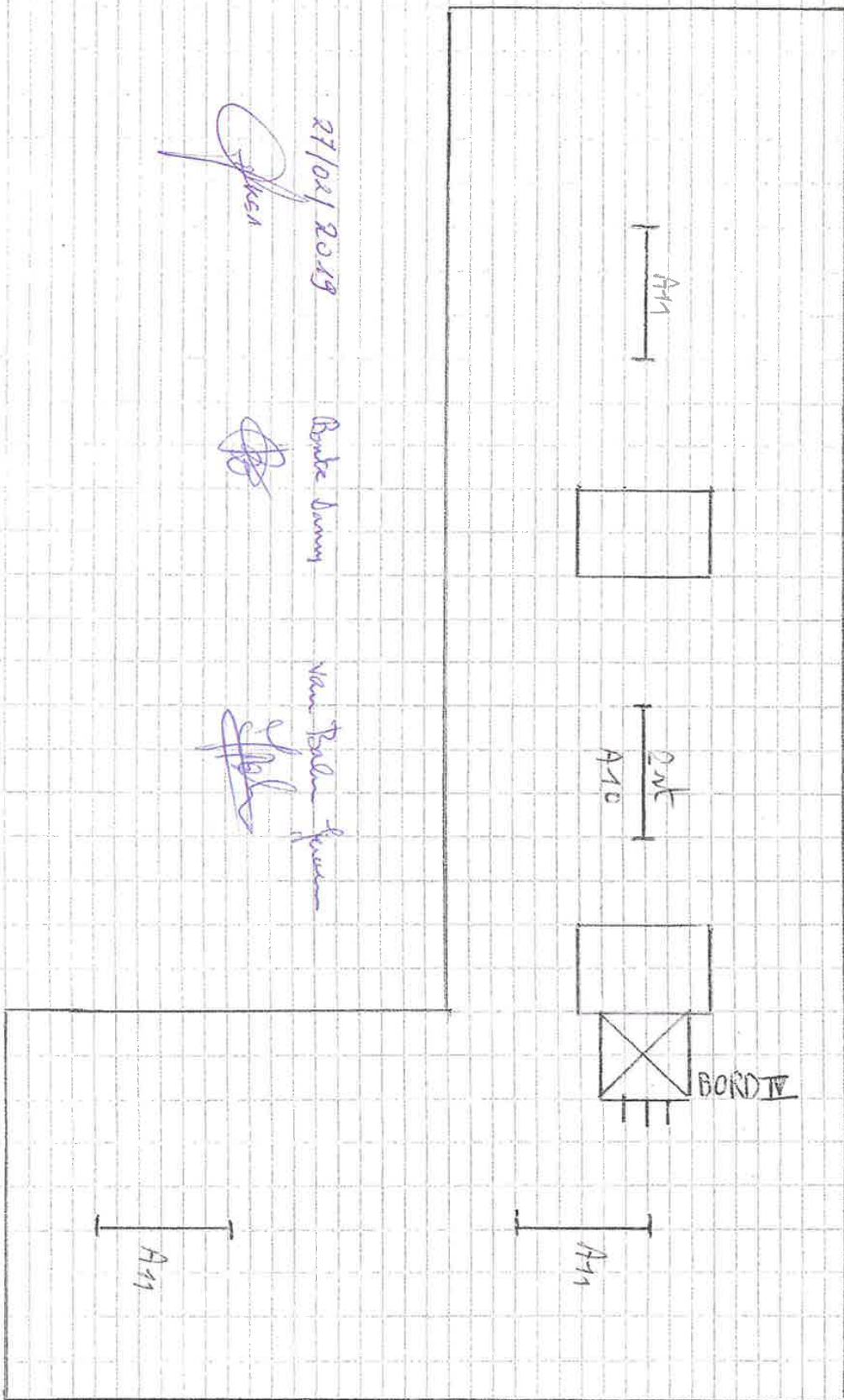

27/02/2019

[Signature]

Boudie Janssen

[Signature]

Van Boven

[Signature]

